



STEELER

SOKÓŁKA

www.steeler.pl

MITSUBISHI PAJERO



INSTRUKCJA MONTAŻU

(Płyta wciągarki)

FITTING INSTRUCTION

(Winch plate)

инструкция монтажа



(Лебедка пластины)

MONTAGEANLEITUNG

(Winch Platte)

PAJERO-PW

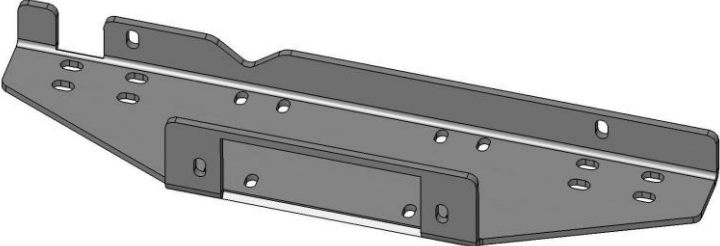
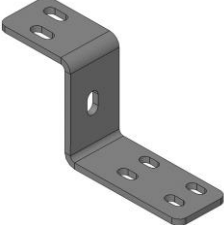
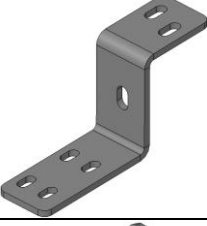
Wykaz elementów:
Specification of full assembly:
Список элементов тюнинга:
Liste der Elemente:

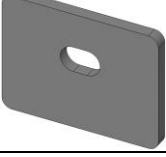
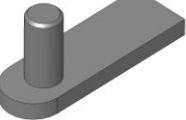
<p>1. Płyta wciągarki (szt. 1) Winch plate (1 pc.) Лебедка пластины (шт.1) Winch Platte (st.1)</p>	
<p>2. Zamocowanie prawe I (szt. 1) Right attachment I (1 pc.) Крепление правое I (шт.1) Montage rechts I (st.1)</p>	
<p>3. Zamocowanie lewe I (szt. 1) Left attachment I (1 pc.) Крепление левое I (шт.1) Montage links I (st.1)</p>	
<p>4. Zamocowanie II (szt.2) Attachment II (2 pcs.) Крепления II (шт.2) Befestigungen II (st.2)</p>	
<p>5. Podkładka I (szt.2) Washer I (2 pcs.) Шайба I (шт.2) Unterlegscheibe I (st.2)</p>	
<p>6. Podkładka II (szt.2) Washer II (2 pcs.) Шайба II (шт.2) Unterlegscheibe II (st.2)</p>	
<p>7. Szpilka M12x25 (szt. 2) Skewer M12x25 (2 pcs.) Шпилька M12x25 (шт.2) Stecknadel M12x25 (st.2)</p>	

Wykaz elementów łącznych:
Connecting components:
Список соединительных элементов:
Die Auflistung der Elemente:

Śruby (szt.) Screws (pcs.) Болты (шт.) Schrauben (st.)	M10x35 – (10) M10x50 – (4) <i>(drobnozwojna-fine tread)</i> M12x140 – (2) M12x25 – (2) <i>(szpilka-skewer)</i>	Nakrętki (szt.) Nuts (pcs.) Гайки (шт.) Muttern (st.)	M10 – (10) M12 – (4)
Podkładki (szt.) Washers (pcs.) Шайбы (шт.) Unterlegscheiben(st.)	Ø 11 – (24)–XL Ø 13 – (4)		



Czas montażu
Fitting time
Время монтажа
Montagezeit



1 h

UWAGA: Folię usunąć dopiero po montażu!
ATTENTION: Foil remove after fitting!
ВНИМАНИЕ: Целлофан снять только после завершения монтажа!
HINWEIS: Die Folie soll erst nach der Montage entfernt werden!

Montaż / Fitting / Монтаж / Montage
PAJERO-PW

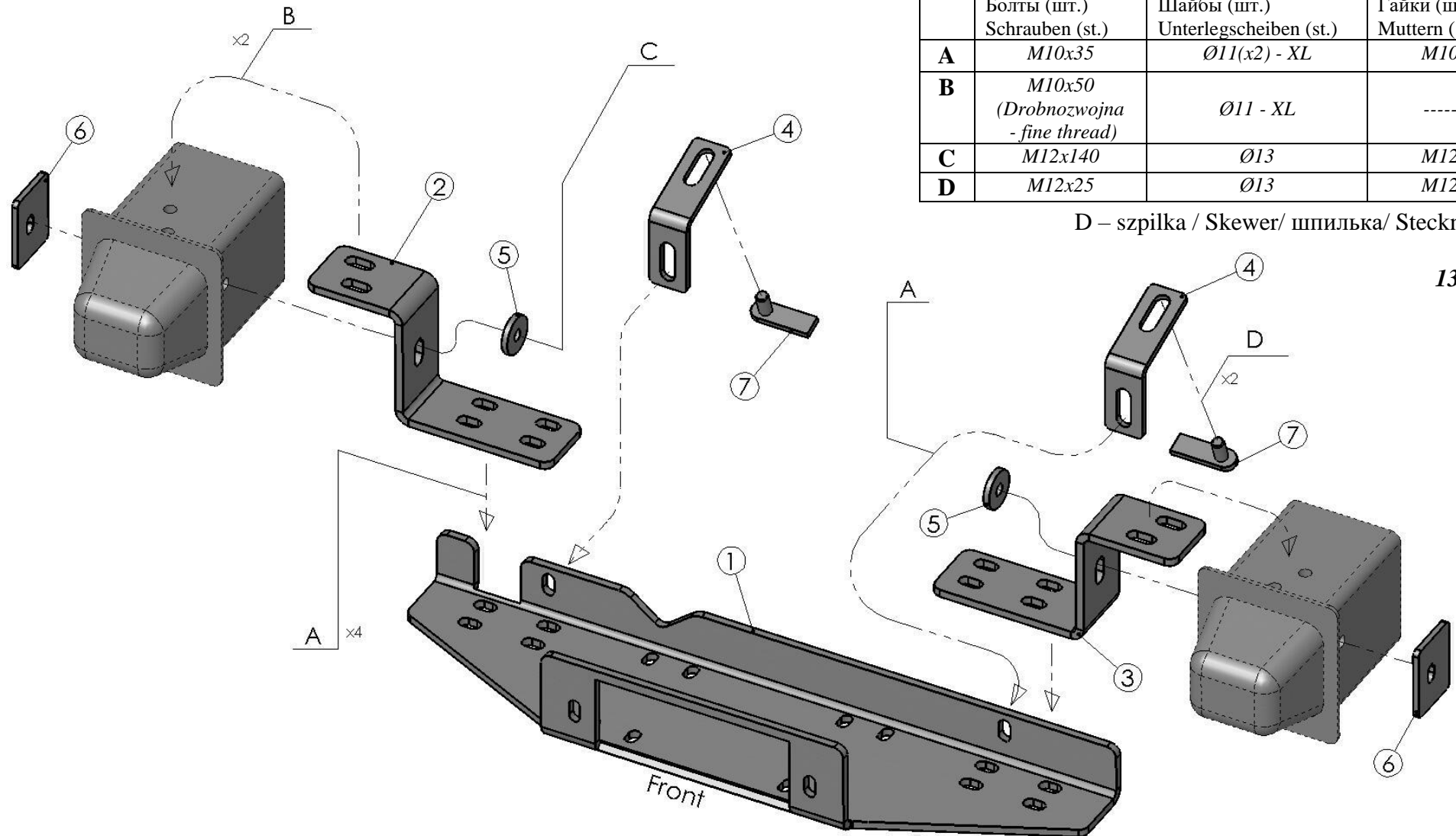

	Śruby (szt.) Screws (pcs.) Болты (шт.) Schrauben (st.)	Podkładki (szt.) Washers (pcs.) Шайбы (шт.) Unterlegscheiben (st.)	Nakrętki (szt.) Nuts (pcs.) Гайки (шт.) Muttern (st.)
A	M10x35	Ø11(x2) - XL	M10
B	M10x50 (Drobnozwojna - fine thread)	Ø11 - XL	-----
C	M12x140	Ø13	M12
D	M12x25	Ø13	M12

D – szpilka / Skewer / шпилька / Stecknadel

13,9kg

Montaż (zdjęcia) / Fitting (pictures) / Монтаж (фотографии)
/ Montage (Fotos)



17
19 46 Nm





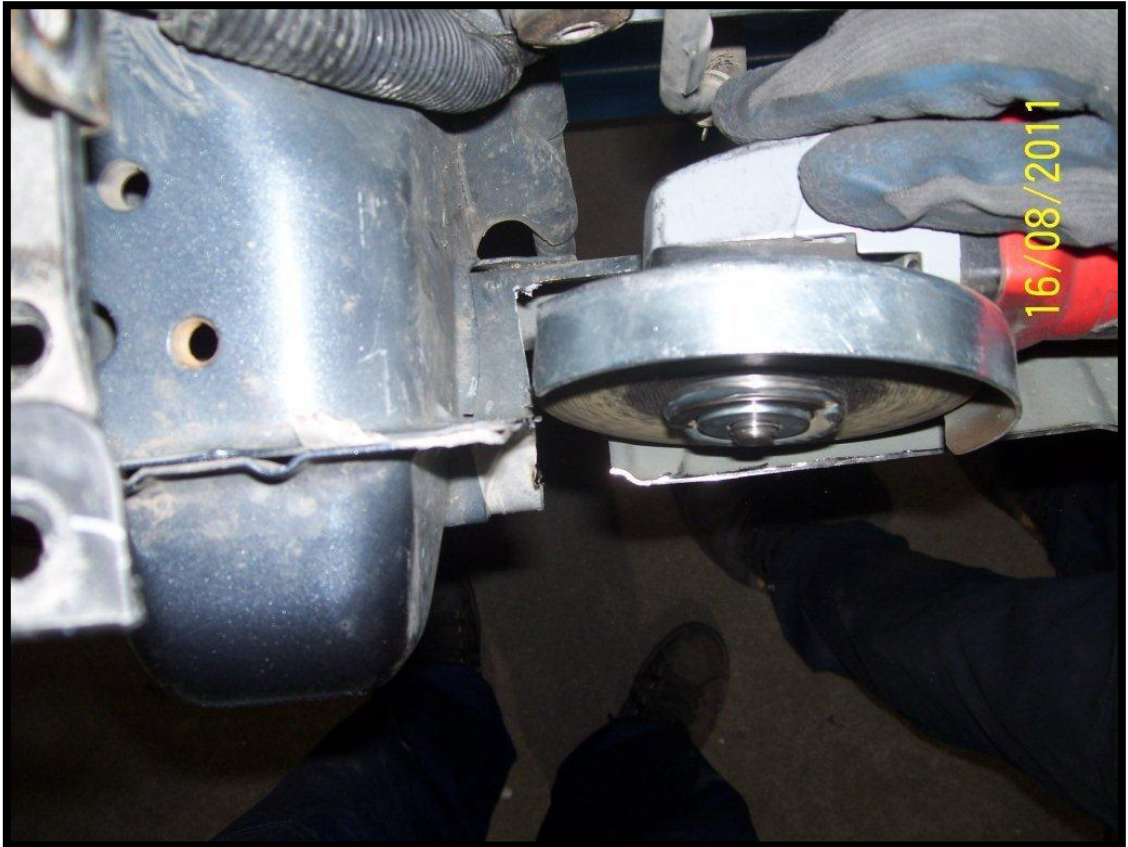







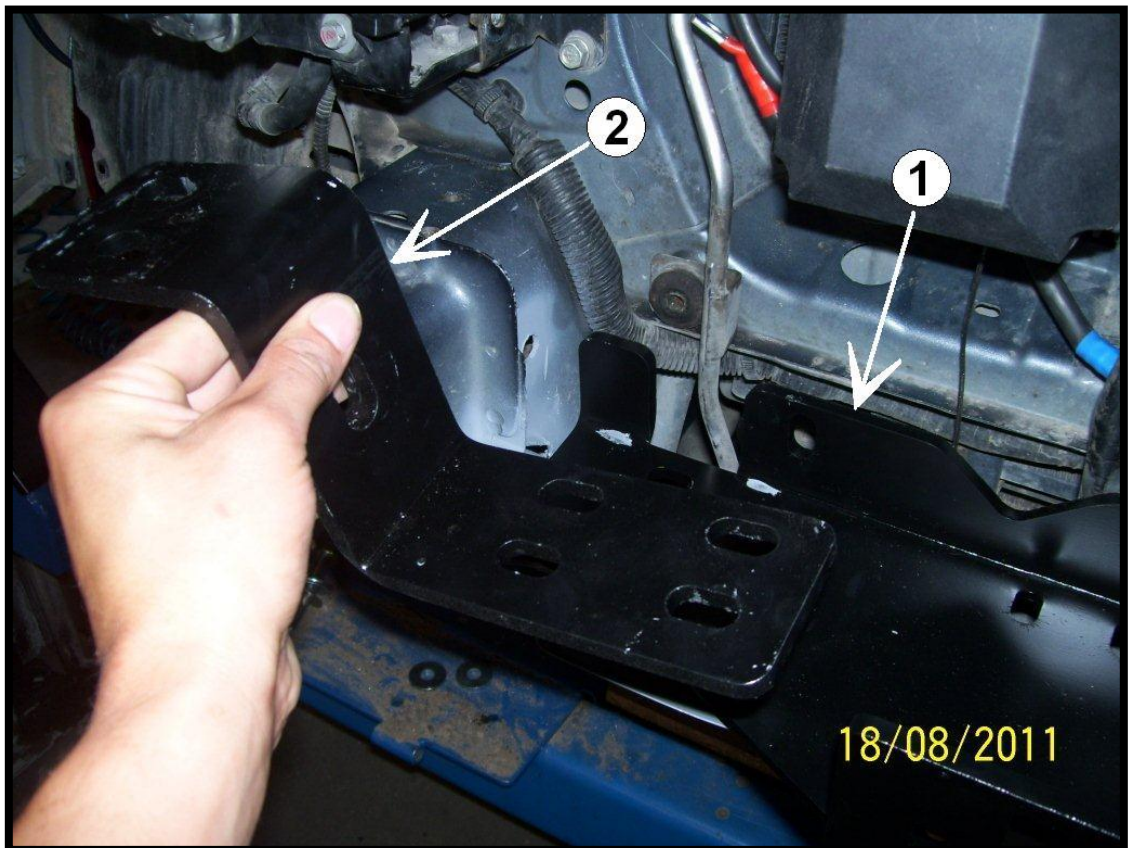
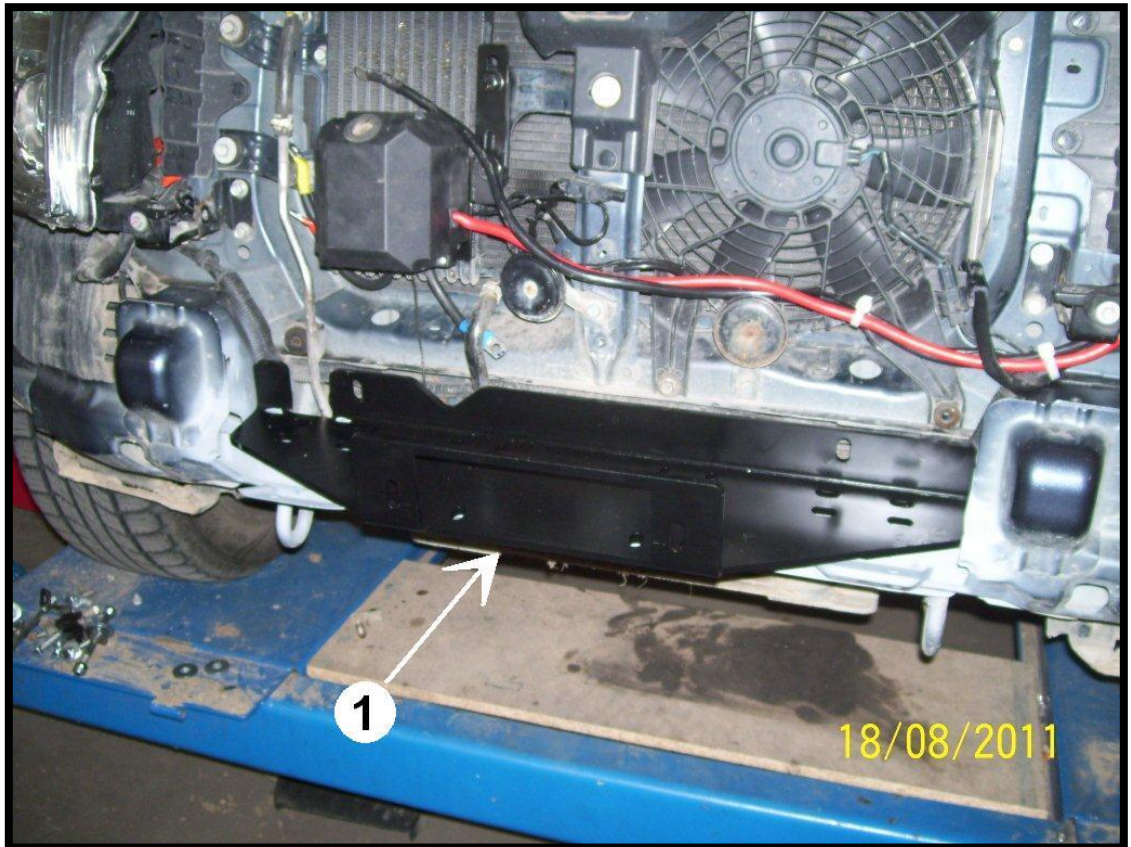

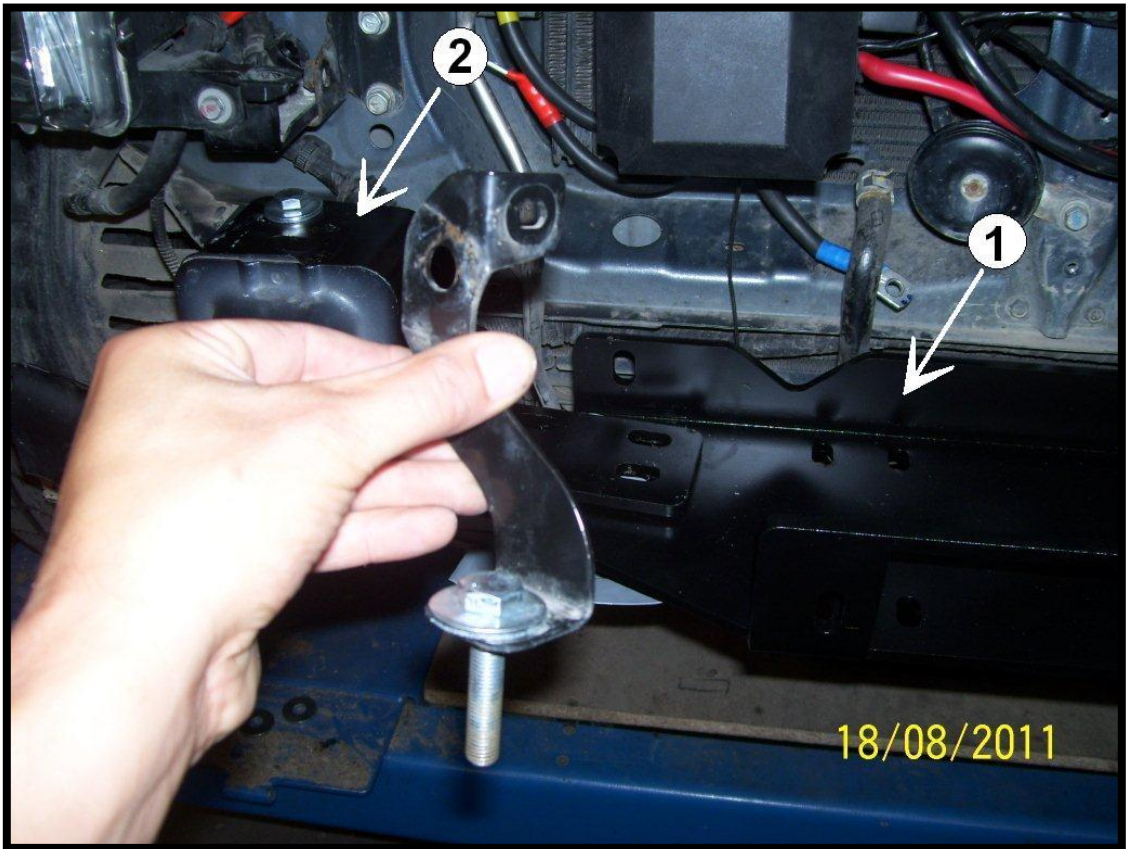
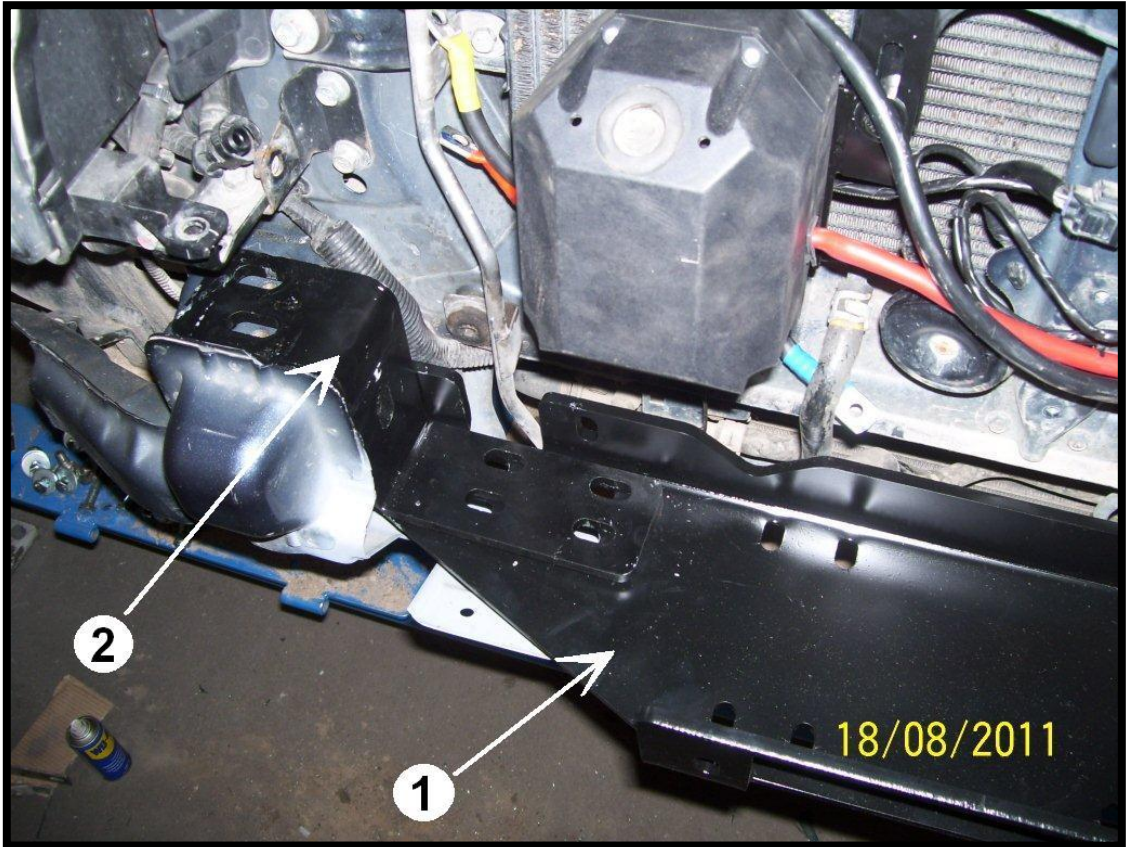

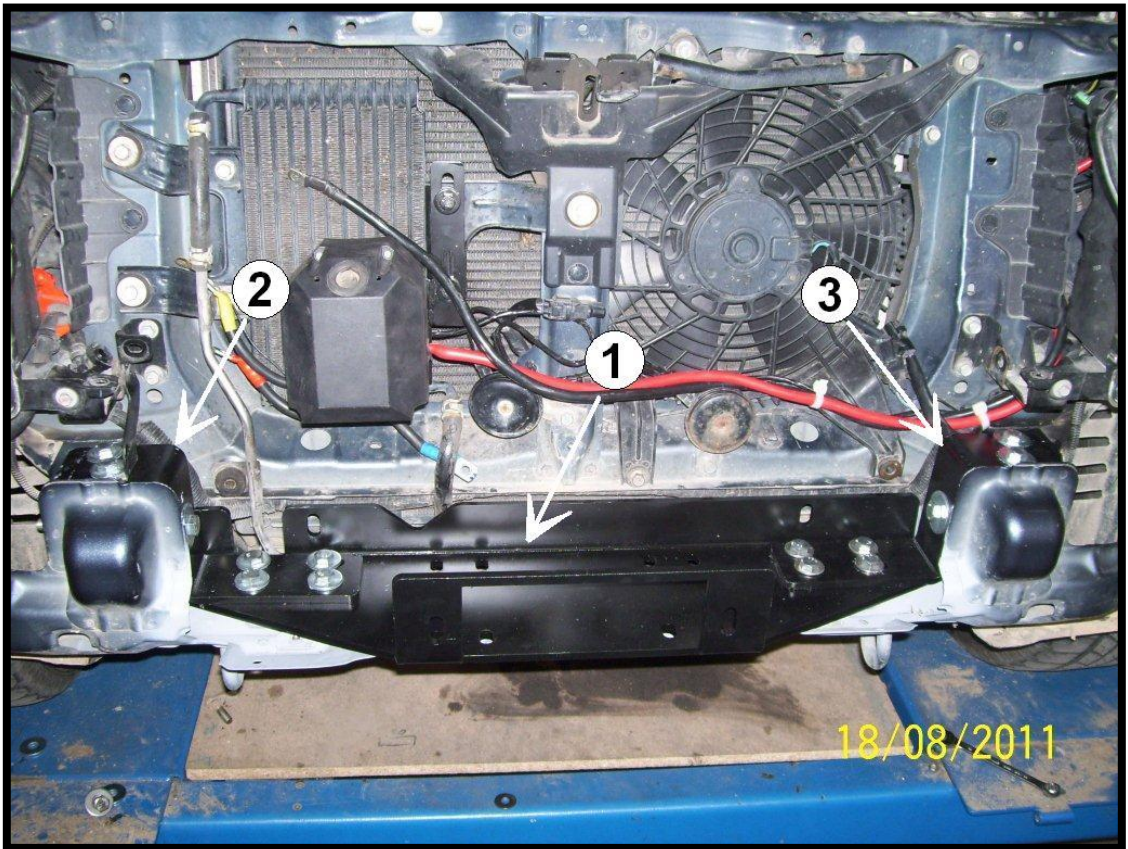
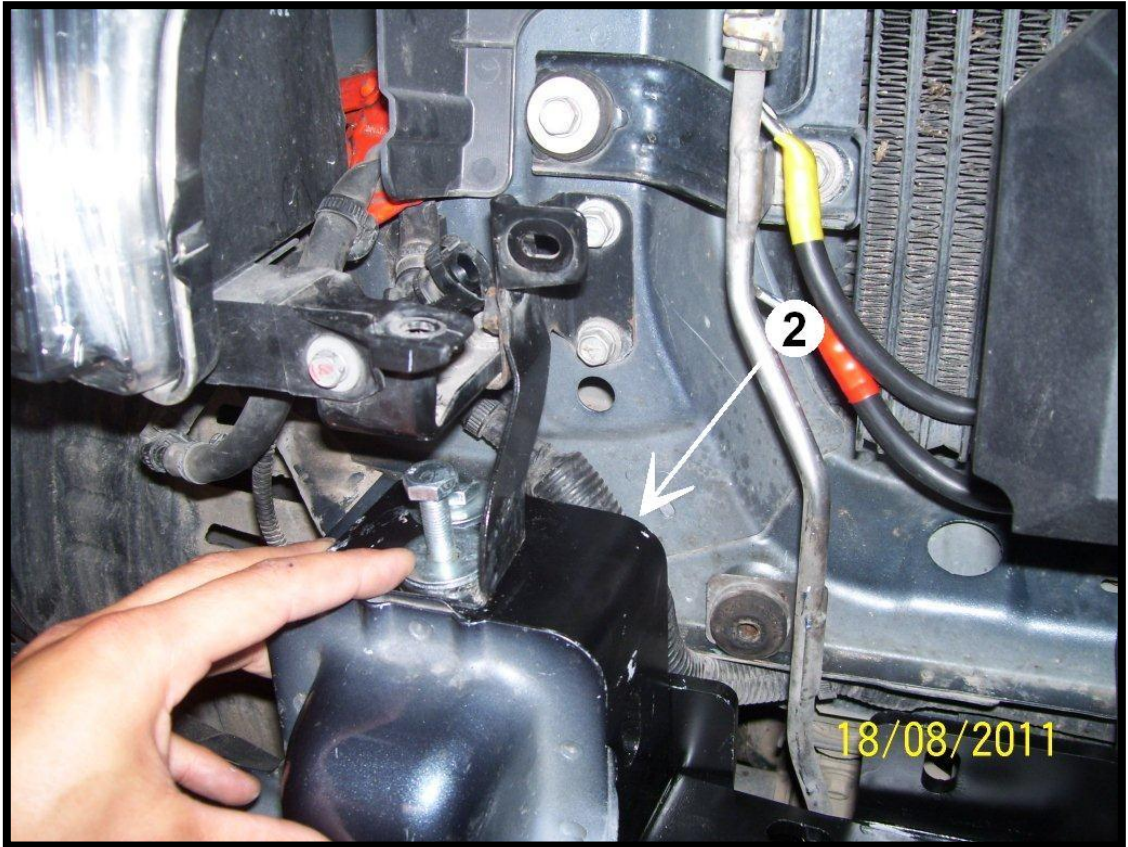

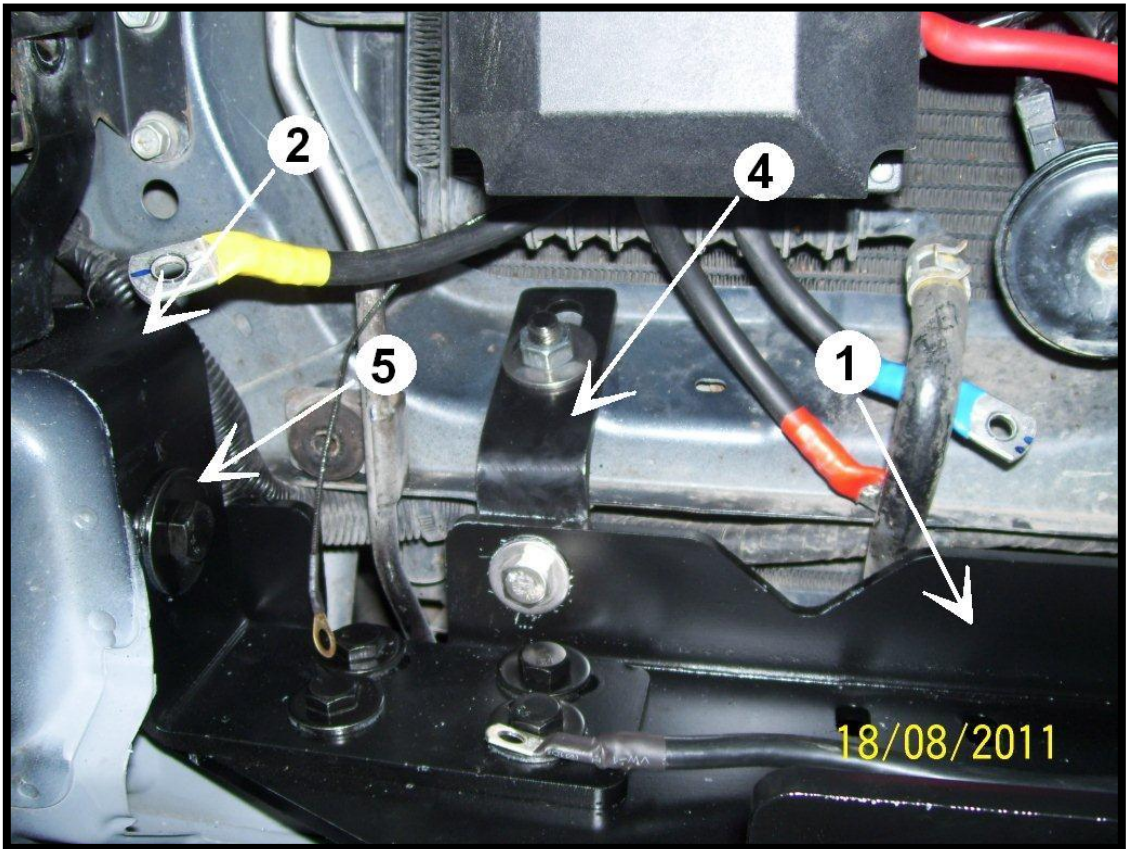
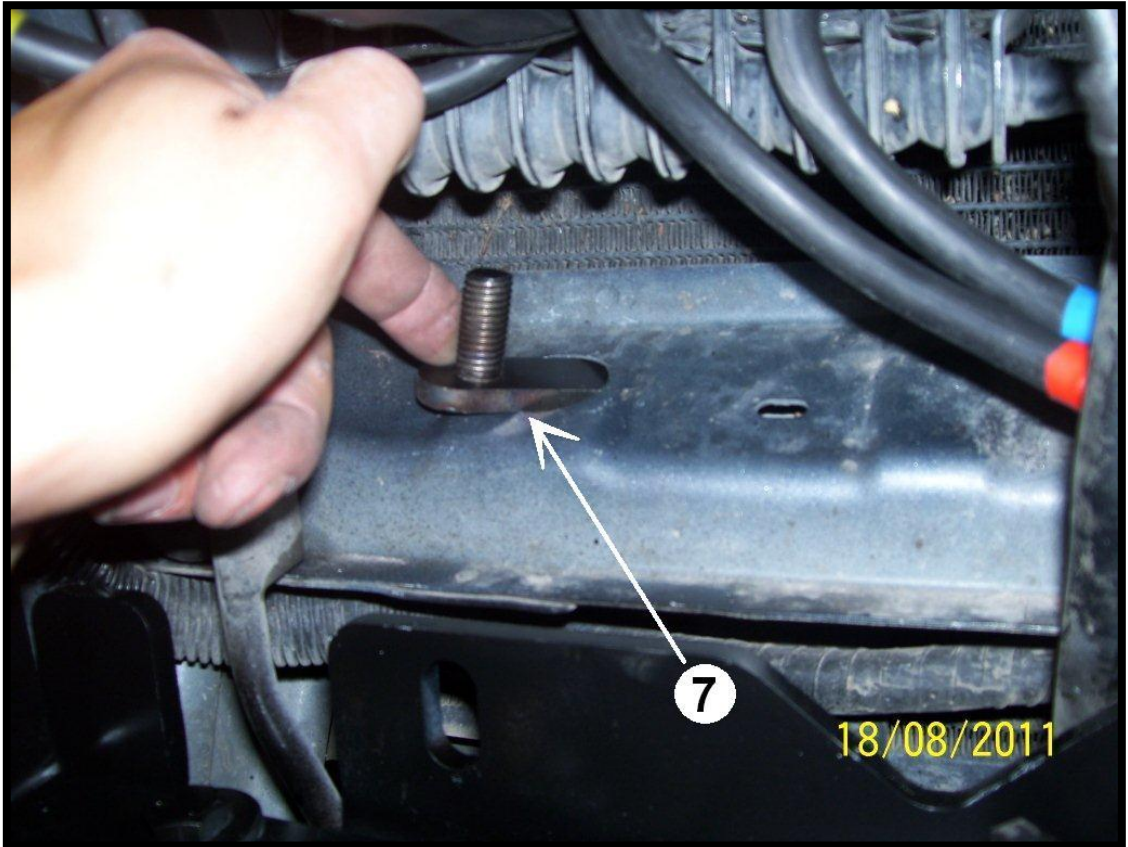

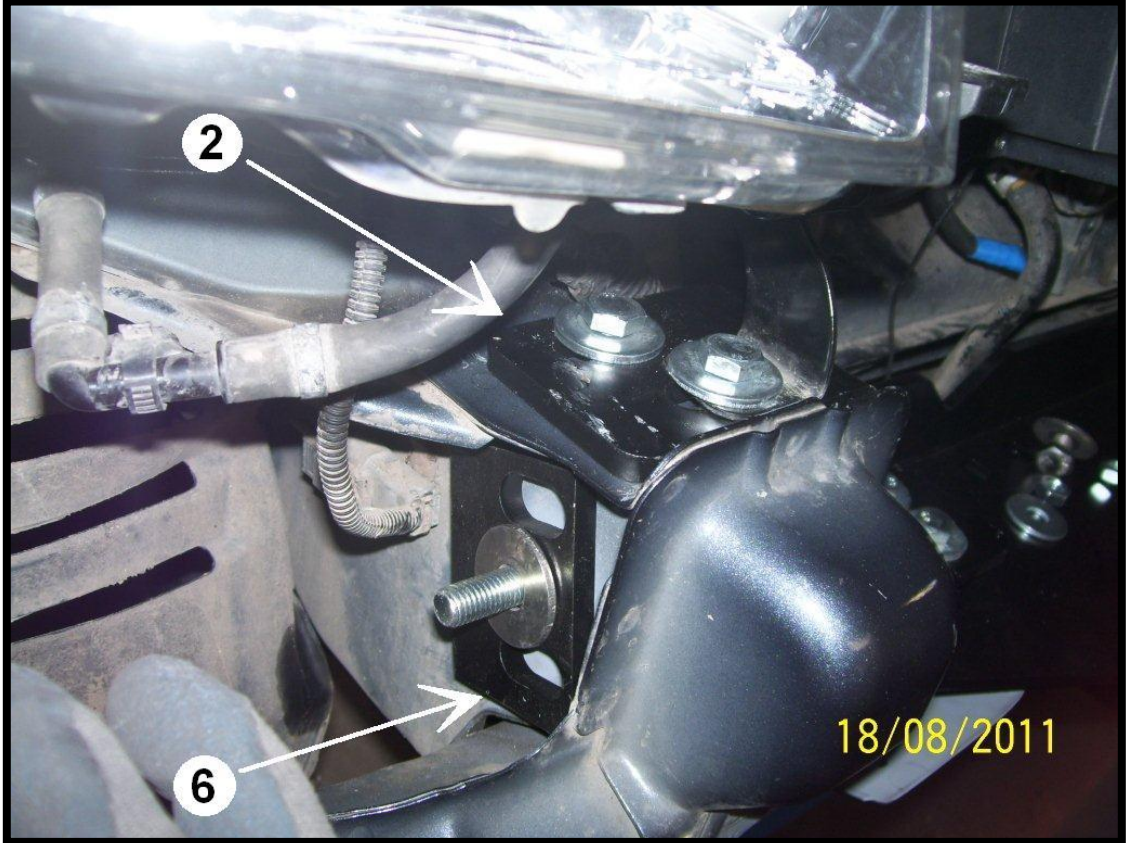
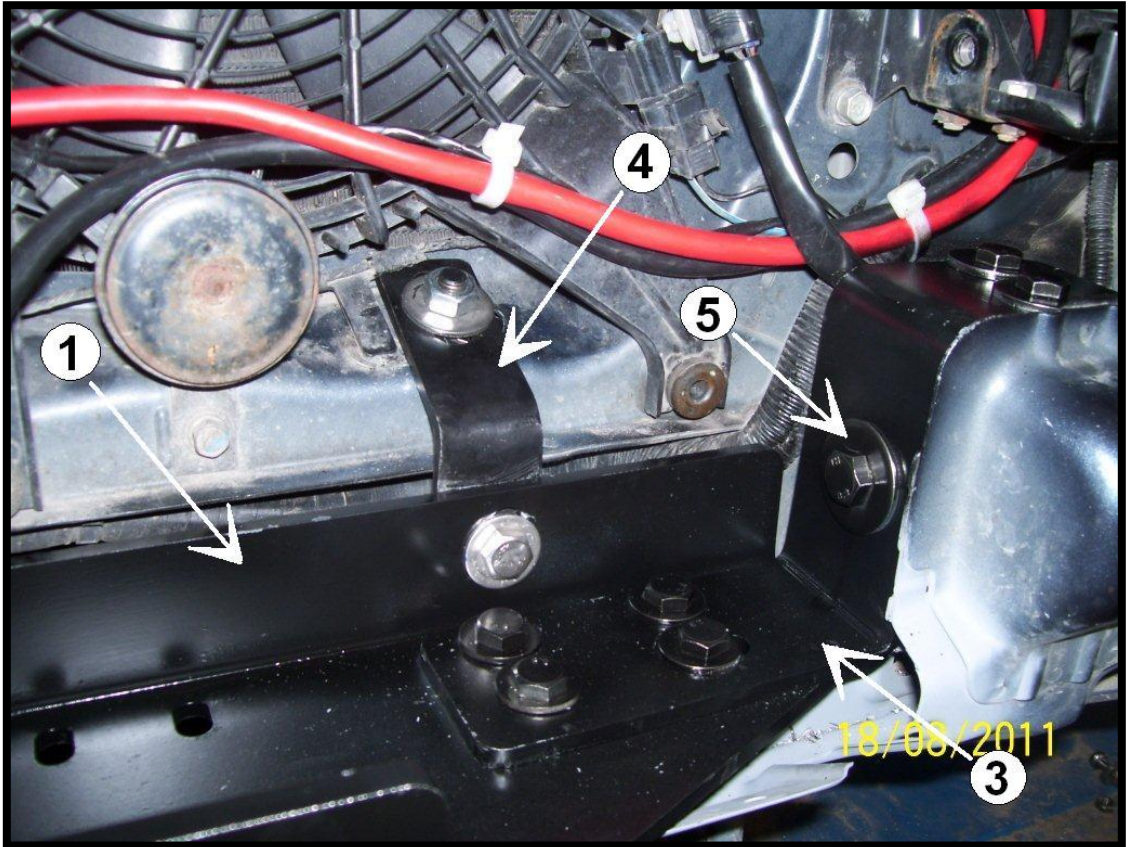

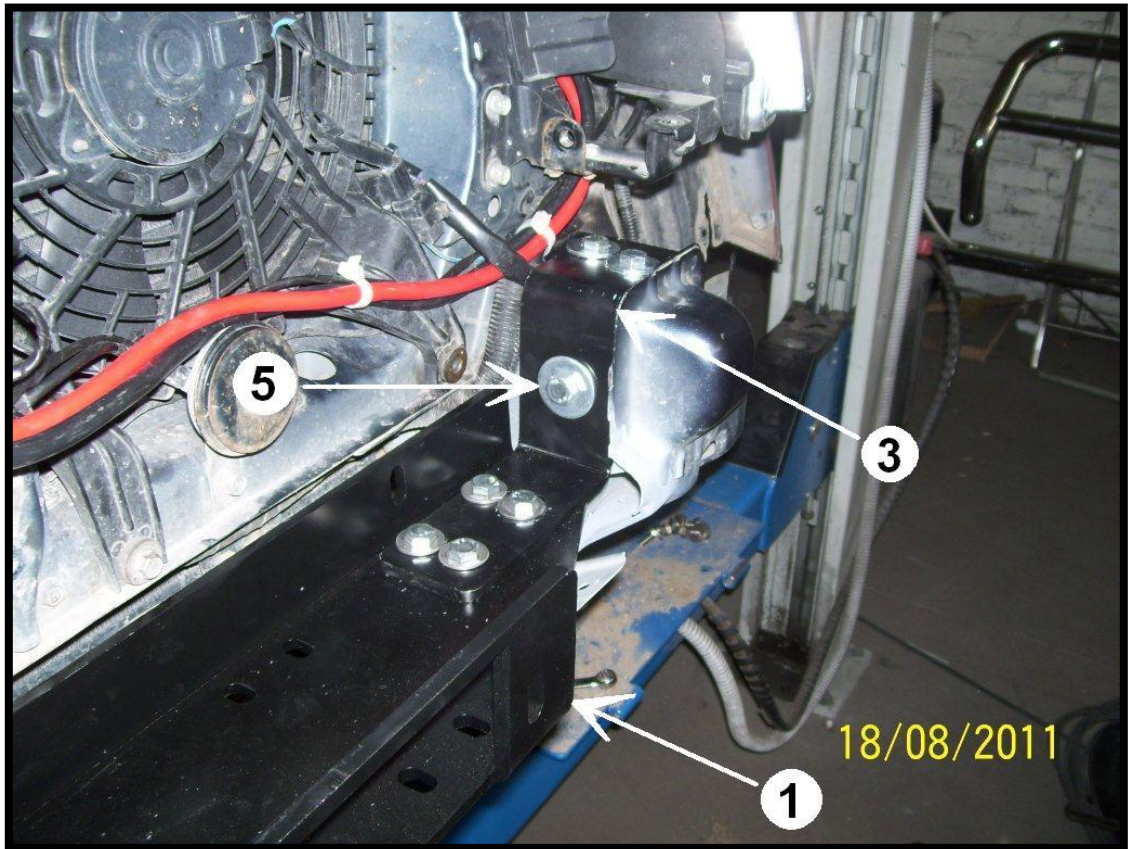
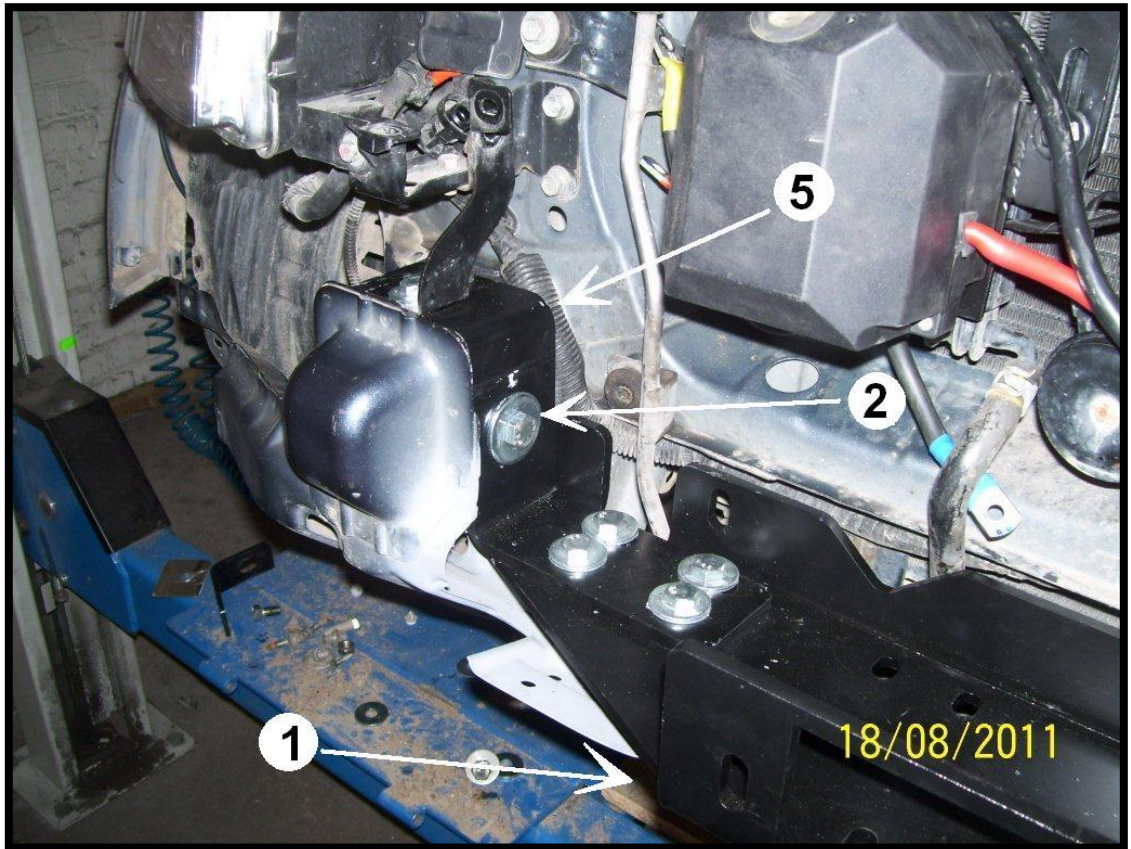

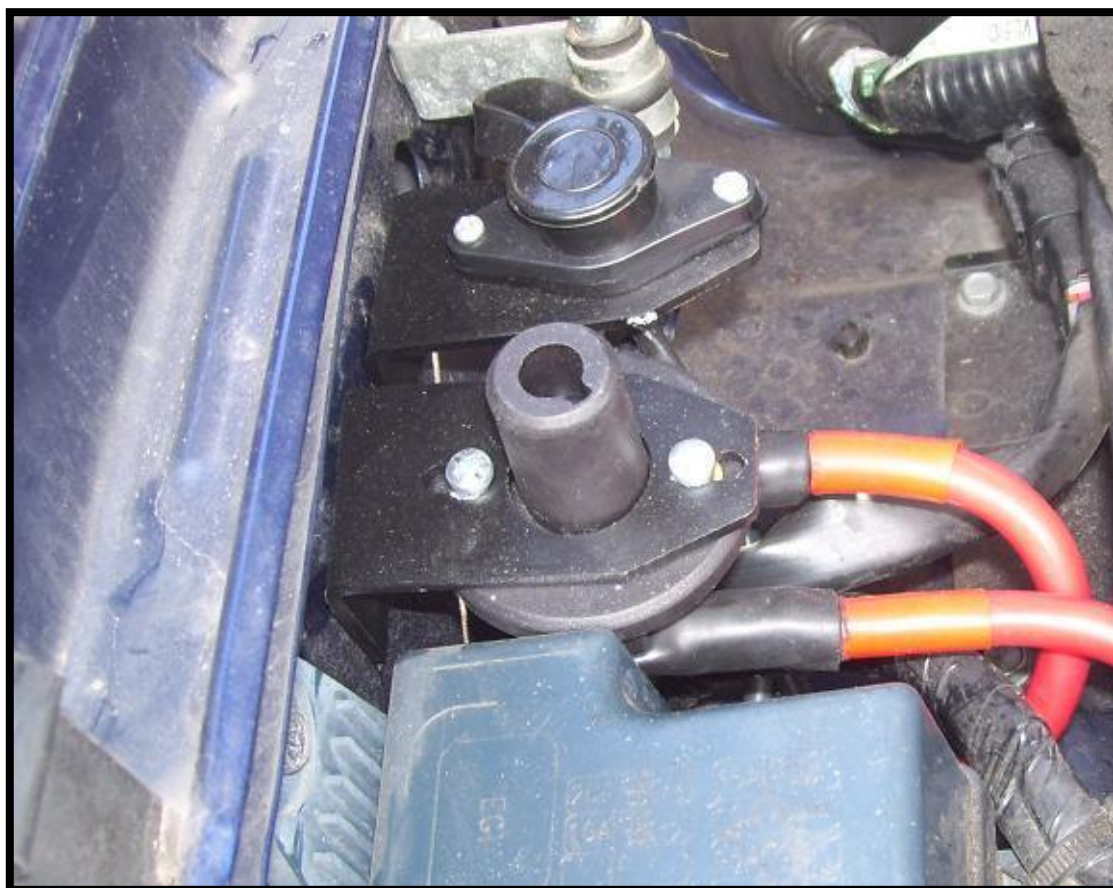

Hebel zabezpieczający (główny wyłącznik prądu)
montuje się w dowolnym miejscu pod maską.

Security main breaker is mounted anywhere under the hood.